



TOP

CRYSTAL-MADE
AND WOODEN
TOP MADE
TO MEASURE



TOP CATEGORIES

CATEGORY 1	CATEGORY 2	CATEGORY 3	CATEGORY 4	CATEGORY 5	CATEGORY 6
<p>MARBLES (thick 2 cm)</p> <p>Carrara White</p> <p>TOP MDF Lacquered MAT/GLOSSY (thick 2 cm)</p> <p>standard colours + ral colours (+12%)</p> <p>VENEERED TOPS (thick 2 cm)</p> <p>standard veneers</p> <p>MELAMINE (thick 2 cm)</p> <p>STANDARD RANGE</p>	<p>MARBLES (thick 2 cm)</p> <p>Trani Pinta green Marquinia Black</p> <p>RESINMARBLE (thick 2 cm)</p> <p>Aosta white Toscana pink Lazio blu Liguria green Botticino Tech Perlato Appia Perlino Rosato Tech Asiago red Carrara Tech Aida white Savanah beige Iceberg white Rigoletto</p>	<p>MARBLES (thick 2 cm)</p> <p>Carrara spacc. white Portogallo pink Travertino Classico st. Guatemala green Pietra Serena Salomè Perlino pink Biancone Sahara Gold Daino Istria yellow Raggio di Luna Calacatta Arabescato Labrador blue White Cristallino Polished arena beige Moka Cream</p> <p>RESINMARBLE (thick 2 cm)</p> <p>Sole Polare Madreperla Orione Maya yellow Giotto Canaletto Duna beige</p> <p><i>Range EVO:</i> Polished Evo Crema Polished Evo White Polished Evo Beige Polished Evo Noce</p>	<p>CRYSTAL-MADE TOP (thick 1,6 cm)</p> <p>TECNORIL® TOP MAT/POLISHED (thick 1,2 cm)</p> <p>MARBLES (thick 2 cm)</p> <p>Kristal white Travertino Resin.Trasp. Karibib Norvegia pink Africa black Botticino Palissandro Assoluto black Lime Stone</p> <p>QUARTZ (thick 2 cm)</p> <p><i>Range SPACCATI:</i> Spaccato White Spaccato Grey Spaccato Black Spaccato Beige Spaccato Brown</p> <p><i>Range STARLIGHT:</i> Starlight Red Starlight Blue Starlight White Starlight Sapphire Starlight Ruby Starlight Black Starlight Gray Starlight Green Starlight Violet Starlight Moka</p> <p><i>Range GEMME:</i> Diamante Lapis Rubino Gris Antracita Polished Beige Arena Polished Beige Arena Spazz. Quarzo Extra White Blanco Paloma Marron Glacè Polished Marron Glacè Spazz. Black Polished T590</p>	<p>CRYSTAL-MADE TOP W/BASIN (thick 1,6 cm)</p> <p><i>Standard colours range:</i> Orange-peel transp. (T100) Total transp. (TT110) Satinèd transp. (TS90) Madreperla (MP95) Ciclamino (CL96) Granito Blue (GB92) Black (NE87) Granito Black (GN63) Granito Pink (GR64) Menta Green (VM65) Dark Green (VS66) Lily (LI90) Blue (A67) Sea Blue (AM68) Meditèr. Blue (AM69) Navy Blue (B70) Grey (G71) Dark Grey (A72) Red Orange (ARX99) Cipria (C73) Acquamarina (A74) Turchese (T75) Pompelmo (P76) Glicine (AG91) Yellow Tucano (GT77) Avana (AV78) Orange (AR79) Bordeaux (B80) Argento (AR81) Tabacco (TC94) Rame (RA93) White (BI84) Mandarino (MA85) Pink Chiaro (RO82) Gold (GOLD93) Pervinca (PE92) Red (RS93) Melanzana (ME98)</p> <p>+ standard colors lacquerings Lasaidea</p>	<p>MAT/POLISHED TECNORIL TOP W/BASIN (thick 1,2 cm)</p> <p>Coloured Tecnoril® (only polished) + 30%</p> <p><i>Colours available:</i> Sabbia RAL1013 BiancoGrigio RAL9002 Panna RAL1015 Grey Beige RAL7600 Navy Blue RAL5000 Lily RAL4009 Vinaccia RAL4007 Seppia RAL8014 Light Grey RAL7004 Grafite RAL7024 Black RAL9005</p>

FEATURES OF TOPS AND THEIR CORRECT USE

MARBLES AND GRANITES

Marbles and granites are natural stones that come out from natural proceedings that last millions of years.. Any slab used for your top can have differences in nuance, small holes due to porosity , less or more evident veins, that can be wider or slimmer, and irregular stains, darker or lighter, smaller or wider. These are not defects but normal feature of the stone, so that there's never one slab of marble like another one .

Cleaning and maintenance:

Any part in marble and granite has been originally treated with anti-stain detergent and wax. For daily use, clean at once with a soft cloth any drop of coffee, lemon, orange, tomato , traces of cosmetics and anything acid. For cleaning, use a normal product for marble and granites and dry at once with a soft cloth. For having these materials shiny, use products that easily can be found in any shop.

RESINMARBLE

Composite slabs with 90% of marble chips, selected for nuance and worth, that are mixed with chemical resins.

Micro-holes on the surface or flakes of different colour are due to the work proceedings, and therefore are not to be considered as defects

Cleaning and maintenance as for marbles and granites.

QUARTZ

Innovative technological material, with remarkable physical- mechanical qualities, that comes from particles of quartzite, silicium grits and polyester resins mixed together and then compressed.

Cleaning and maintenance as for marbles and granites.

CRYSTAL GLASS

The well-known features of resistance to external agents, along with its undisputed elegance, are ideal for its use in the world of bathroom furniture. For fitting the crystal-made top , use non-acetic neutral silicone.

Cleaning and maintenance of crystal glass:

Use common detergents for glass. For hard stains due to limestone and soaps, clean with anti-limestone detergents as vinegar, viakal, ajax.

Clean with warm water then dry with a soft cloth.

MAT/POLISHED TECNORIL®

Slabs of solid tech material and not porous of acrylic resin and tri-hydrate of aluminium, that comes from bauxite. Polished Tecnoril is coated with an additional polyester /acrylic resin film that supports the glazing proceeding. The smooth sensation of Tecnoril when you touch it ,that gives the idea of a natural element, gives an unexpected sensation of pleasance. Tecnoril has a high resistance to acids , basic elements, stains, scratches, grazes, wear and tear of time and the typical stress due to daily use.

Thanks to its features , Tecnoril is , among the solid surfaces, in the highest positions -for chemical and mechanical resistances- and these features are continuously tested and stressed in accordance to the current european legislations.

Cleaning and maintenance of mat Tecnoril:

Surfaces can easily be cleaned with water and dried with a soft cloth, and in case of hard stains, cleaned with a liquid soap and soft. And soft sponge.

In case of stains due to limestone, use an anti-limestone detergent as viakal or ajax or vinegar. Then clean with warm water and dry with a soft cloth.

In case of stains due to lipstick, felt-tipped pen, grease, use a solution with warm water and 10% ammonia, then clean with a soft cloth.

Do not lean lit cigarettes on the top as well as do not cut anything on the top, but always use a a chopboard.

Cleaning and maintenance for polished Tecnoril:

For removing the most of the stains, the dirt and limestone and not damaging the shiny surfaces of Tecnoril, we suggest the use of a solution of water and soap or common non -abrasive detergents with a non -abrasive sponge or soft cotton cloth, carefully cleaning with water before drying with a soft cloth. Do not leave anything red-hot on the top as well as do not leave lit cigarettes on the top. Do not cut anything on the top but use a a chopboard between the object to cut and the top.

It's possible to recover deep scratches, light splits, super hard stains with normal maintenance. If the geacrill filmthat coats the surface has not been damaged in its total thickness, please call a specialized centre that will sand-paper with a very thin abrasive paper (grain 800-1000) as long as it has erased the scratch and levelled the surface. For returning to the original brilliance, please use a polish cream (the same cream used for cars), following instructions.

VENEERED, MELAMINE AND LACQUERED TOPS:

Veneered tops require a higher care than the other materials, but for preserving the original nuance and colours please place veneered parts where are not directly exposed to sun rays and please remove at once any drop of water or liquid from its surface.

Cleaning and maintenance of veneered, melamine and lacquered tops:

Use only a moistened soft cloth, and avoid any detergent, soap and abrasive material.

HALF BUILT-IN

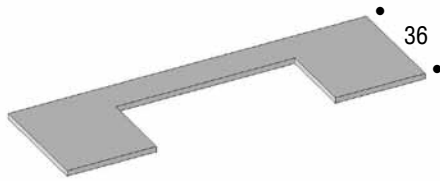

IMPORTANT:

Always write the basin model.

Surcharge for 3 cm thick tops +27%

surcharge for second drill for basin:

half built-in Art. SC130 € 36

Art.	Width from cm to cm	CATEGORY 1 marble, veneered, lacquered, melamine	CATEGORY 2 marble	CATEGORY 3 marble	CATEGORY 4 marble, crystal glass, Mat/polished Tecnoril
TP100	up to cm 70	Avail.	Avail.	Avail.	Avail.
TP101	fr. cm 70,1 to 80	Avail.	Avail.	Avail.	Avail.
TP102	fr. cm 80,1 to 90	Avail.	Avail.	Avail.	Avail.
TP103	fr. cm 90,1 to 100	Avail.	Avail.	Avail.	Avail.
TP104	fr. cm 100,1 to 110	Avail.	Avail.	Avail.	Avail.
TP105	fr. cm 110,1 to 120	Avail.	Avail.	Avail.	Avail.
TP106	fr. cm 120,1 to 130	Avail.	Avail.	Avail.	Avail.
TP107	fr. cm 130,1 to 140	Avail.	Avail.	Avail.	Avail.
TP108	fr. cm 140,1 to 150	Avail.	Avail.	Avail.	Avail.
TP109	fr. cm 150,1 to 160	Avail.	Avail.	Avail.	Avail.
TP110	fr. cm 160,1 to 170	Avail.	Avail.	Avail.	Avail.
TP111	fr. cm 170,1 to 180	Avail.	Avail.	Avail.	Avail.
TP112	fr. cm 180,1 to 190	Avail.	Avail.	Avail.	Avail.
TP113	fr. cm 190,1 to 200	Avail.	Avail.	Avail.	Avail.
TP114	fr. cm 200,1 to 210	Avail.	Avail.	Avail.	Avail.

2 cm thick marble; 1,6 cm thick crystal glass; 1,2 cm thick Tecnoril

DRILLED OR UNDRILLED FOR BASINS TO LEAN

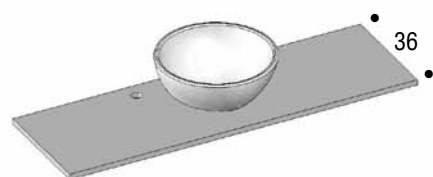
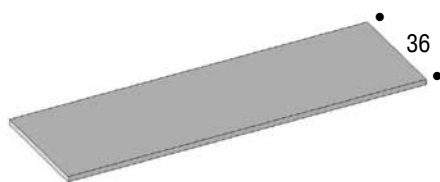

IMPORTANT:

For having the right drill for basin to lean, please always write the basin model, the position you want the drill (left/centre/right) for the draining tube and the drill for the fawcet.

Surcharge for 3 cm thick tops +27%

surcharge for second drill for basin:

to lean Art. AP131 € XX

Art.	Width from cm to cm	CATEGORY 1 marble, veneered, lacquered, melamine	CATEGORY 2 marble	CATEGORY 3 marble	CATEGORY 4 marble, crystal glass, Mat/polished Tecnoril
TP149	up to cm 60	Avail.	Avail.	Avail.	Avail.
TP150	fr. cm 60,1 to 70	Avail.	Avail.	Avail.	Avail.
TP151	fr. cm 70,1 to 80	Avail.	Avail.	Avail.	Avail.
TP152	fr. cm 80,1 to 90	Avail.	Avail.	Avail.	Avail.
TP153	fr. cm 90,1 to 100	Avail.	Avail.	Avail.	Avail.
TP154	fr. cm 100,1 to 110	Avail.	Avail.	Avail.	Avail.
TP155	fr. cm 110,1 to 120	Avail.	Avail.	Avail.	Avail.
TP156	fr. cm 120,1 to 130	Avail.	Avail.	Avail.	Avail.
TP157	fr. cm 130,1 to 140	Avail.	Avail.	Avail.	Avail.
TP158	fr. cm 140,1 to 150	Avail.	Avail.	Avail.	Avail.
TP159	fr. cm 150,1 to 160	Avail.	Avail.	Avail.	Avail.
TP160	fr. cm 160,1 to 170	Avail.	Avail.	Avail.	Avail.
TP161	fr. cm 170,1 to 180	Avail.	Avail.	Avail.	Avail.
TP162	fr. cm 180,1 to 190	Avail.	Avail.	Avail.	Avail.
TP163	fr. cm 190,1 to 200	Avail.	Avail.	Avail.	Avail.
TP164	fr. cm 200,1 to 210	Avail.	Avail.	Avail.	Avail.

2 cm thick marble; 1,6 cm thick crystal glass; 1,2 cm thick Tecnoril

DRILLED OR UNDRILLED FOR BASINS TO LEAN

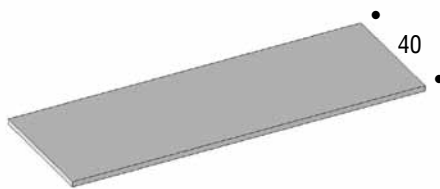

IMPORTANT:

For having the right drill for basin to lean, please always write the basin model, the position you want the drill (left/centre/right) for the draining tube and the drill for the faucet..

Surcharge for 3 cm thick tops +27%

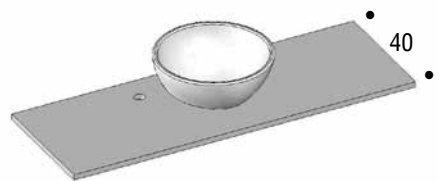

surcharge for second drill for basin:

to lean Art. AP131 € XX

Art.	Width from cm to cm	CATEGORY 1 marble, veneered, lacquered, melamine	CATEGORY 2 marble	CATEGORY 3 marble	CATEGORY 4 marble, crystal glass, Mat/polished Tecnoril
TP261	up to cm 60	Avail.	Avail.	Avail.	Avail.
TP262	fr. cm 60,1 to 70	Avail.	Avail.	Avail.	Avail.
TP263	fr. cm 70,1 to 80	Avail.	Avail.	Avail.	Avail.
TP264	fr. cm 80,1 to 90	Avail.	Avail.	Avail.	Avail.
TP265	fr. cm 90,1 to 100	Avail.	Avail.	Avail.	Avail.
TP266	fr. cm 100,1 to 110	Avail.	Avail.	Avail.	Avail.
TP267	fr. cm 110,1 to 120	Avail.	Avail.	Avail.	Avail.
TP268	fr. cm 120,1 to 130	Avail.	Avail.	Avail.	Avail.
TP269	fr. cm 130,1 to 140	Avail.	Avail.	Avail.	Avail.
TP270	fr. cm 140,1 to 150	Avail.	Avail.	Avail.	Avail.
TP271	fr. cm 150,1 to 160	Avail.	Avail.	Avail.	Avail.
TP272	fr. cm 160,1 to 170	Avail.	Avail.	Avail.	Avail.
TP273	fr. cm 170,1 to 180	Avail.	Avail.	Avail.	Avail.
TP274	fr. cm 180,1 to 190	Avail.	Avail.	Avail.	Avail.
TP275	fr. cm 190,1 to 200	Avail.	Avail.	Avail.	Avail.
TP276	fr. cm 200,1 to 210	Avail.	Avail.	Avail.	Avail.

2 cm thick marble; 1,6 cm thick crystal glass; 1,2 cm thick Tecnoril

UNDRILLED, WITH UNDERTOP / OVERTOP DRILL OR FOR BASIN TO LEAN

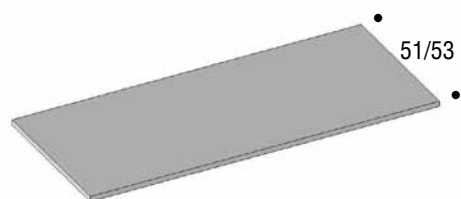

IMPORTANT:

Always write the basin model.

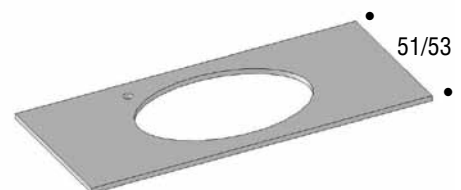

Surcharge for 3 cm thick tops +27%

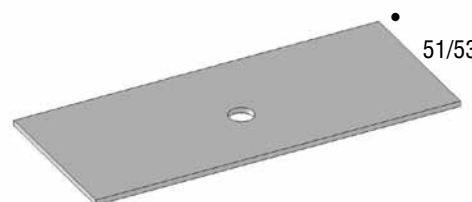
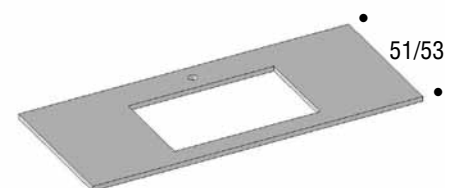

surcharge for second drill for basin:

*undertop
to lean/overtop*

Art. LA132 € XX
Art. AP131 € XX

Art.	Width from cm to cm	CATEGORY 1 marble, veneered, lacquered, melamine	CATEGORY 2 marble	CATEGORY 3 marble	CATEGORY 4 marble, crystal glass, Mat/polished Tecnoril
TP280	up to cm 60	Avail.	Avail.	Avail.	Avail.
TP281	fr. cm 60,1 to 70	Avail.	Avail.	Avail.	Avail.
TP282	fr. cm 70,1 to 80	Avail.	Avail.	Avail.	Avail.
TP283	fr. cm 80,1 to 90	Avail.	Avail.	Avail.	Avail.
TP284	fr. cm 90,1 to 100	Avail.	Avail.	Avail.	Avail.
TP285	fr. cm 100,1 to 110	Avail.	Avail.	Avail.	Avail.
TP286	fr. cm 110,1 to 120	Avail.	Avail.	Avail.	Avail.
TP287	fr. cm 120,1 to 130	Avail.	Avail.	Avail.	Avail.
TP288	fr. cm 130,1 to 140	Avail.	Avail.	Avail.	Avail.
TP289	fr. cm 140,1 to 150	Avail.	Avail.	Avail.	Avail.
TP290	fr. cm 150,1 to 160	Avail.	Avail.	Avail.	Avail.
TP291	fr. cm 160,1 to 170	Avail.	Avail.	Avail.	Avail.
TP292	fr. cm 170,1 to 180	Avail.	Avail.	Avail.	Avail.
TP293	fr. cm 180,1 to 190	Avail.	Avail.	Avail.	Avail.
TP294	fr. cm 190,1 to 200	Avail.	Avail.	Avail.	Avail.
TP295	fr. cm 200,1 to 210	Avail.	Avail.	Avail.	Avail.
TP296	fr. cm 210,1 to 220	Avail.	Avail.	Avail.	Avail.

2 cm thick marble; 1,6 cm thick crystal glass; 1,2 cm thick Tecnoril

UNDRILLED, WITH UNDERTOP / OVERTOP DRILL OR FOR BASIN TO LEAN

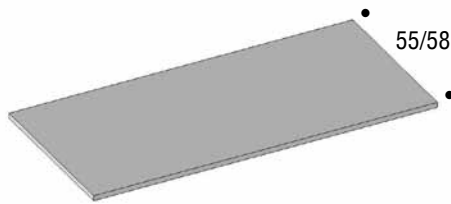

IMPORTANT:

Always write the basin model.

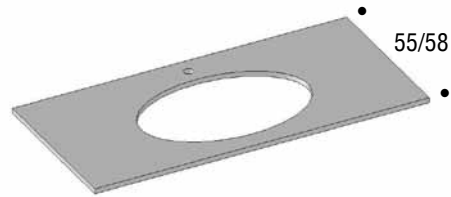

Surcharge for 3 cm thick tops +27%

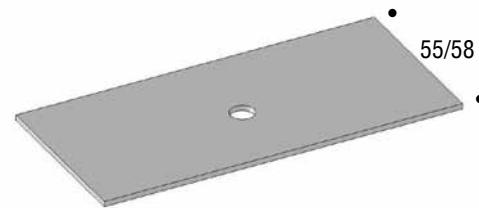
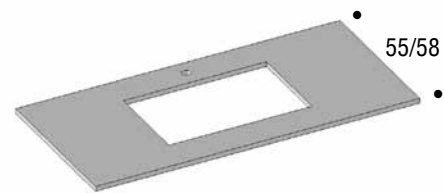

surcharge for second drill for basin:

*undertop
to lean/overtop*

Art. LA132 € XX

Art. AP131 € XX

Art.	Width from cm to cm	CATEGORY 1 marble, veneered, lacquered, melamine	CATEGORY 2 marble	CATEGORY 3 marble	CATEGORY 4 marble, crystal glass, Mat/polished Tecnoril
TP320	up to cm 60	Avail.	Avail.	Avail.	Avail.
TP321	fr. cm 60,1 to 70	Avail.	Avail.	Avail.	Avail.
TP322	fr. cm 70,1 a 80	Avail.	Avail.	Avail.	Avail.
TP323	fr. cm 80,1 a 90	Avail.	Avail.	Avail.	Avail.
TP324	fr. cm 90,1 a 100	Avail.	Avail.	Avail.	Avail.
TP325	fr. cm 100,1 a 110	Avail.	Avail.	Avail.	Avail.
TP326	fr. cm 110,1 a 120	Avail.	Avail.	Avail.	Avail.
TP327	fr. cm 120,1 a 130	Avail.	Avail.	Avail.	Avail.
TP328	fr. cm 130,1 a 140	Avail.	Avail.	Avail.	Avail.
TP329	fr. cm 140,1 a 150	Avail.	Avail.	Avail.	Avail.
TP330	fr. cm 150,1 a 160	Avail.	Avail.	Avail.	Avail.
TP331	fr. cm 160,1 a 170	Avail.	Avail.	Avail.	Avail.
TP332	fr. cm 170,1 a 180	Avail.	Avail.	Avail.	Avail.
TP333	fr. cm 180,1 a 190	Avail.	Avail.	Avail.	Avail.
TP334	fr. cm 190,1 a 200	Avail.	Avail.	Avail.	Avail.
TP335	fr. cm 200,1 a 210	Avail.	Avail.	Avail.	Avail.
TP336	fr. cm 210,1 a 220	Avail.	Avail.	Avail.	Avail.

2 cm thick marble; 1,6 cm thick crystal glass; 1,2 cm thick Tecnoril

UNDRILLED, WITH UNDERTOP / OVERTOP DRILL OR FOR BASIN TO LEAN

IMPORTANT:

Always write the basin model.

Surcharge for 3 cm thick tops +27%

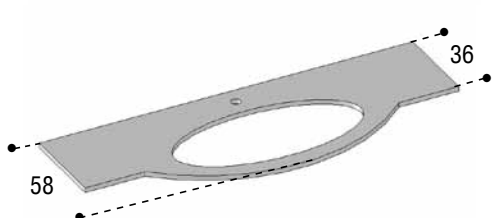
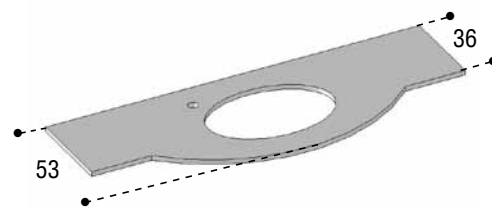
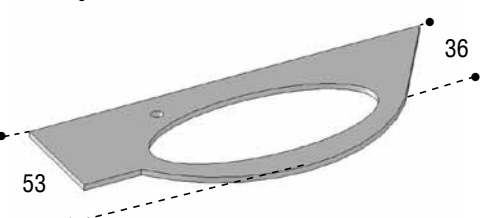
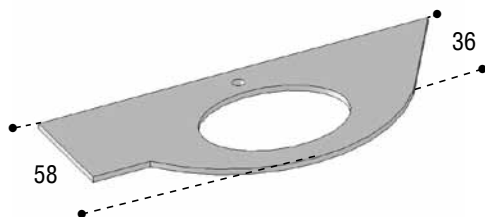
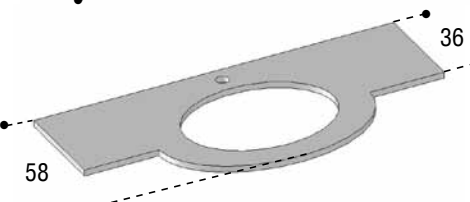
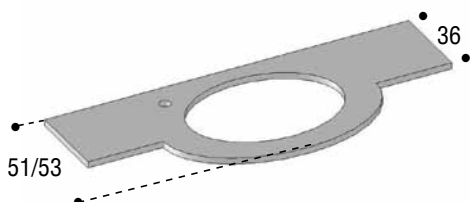
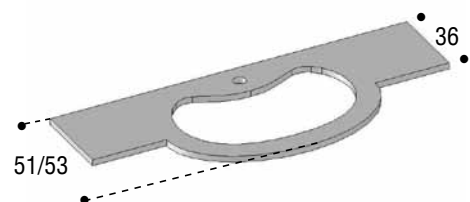

surcharge for second drill for basin:

*undertop
to lean/overtop*

Art. LA132 € XX

Art. AP131 € XX

Art.	Width from cm to cm	CATEGORY 1 marble, veneered, lacquered, melamine	CATEGORY 2 marble	CATEGORY 3 marble	CATEGORY 4 marble, crystal glass, Mat/polished Tecnoril
TP340	up to cm 70	Avail.	Avail.	Avail.	Avail.
TP341	fr. cm 70,1 to 80	Avail.	Avail.	Avail.	Avail.
TP342	fr. cm 80,1 to 90	Avail.	Avail.	Avail.	Avail.
TP343	fr. cm 90,1 to 100	Avail.	Avail.	Avail.	Avail.
TP344	fr. cm 100,1 to 110	Avail.	Avail.	Avail.	Avail.
TP345	fr. cm 110,1 to 120	Avail.	Avail.	Avail.	Avail.
TP346	fr. cm 120,1 to 130	Avail.	Avail.	Avail.	Avail.
TP347	fr. cm 130,1 to 140	Avail.	Avail.	Avail.	Avail.
TP348	fr. cm 140,1 to 150	Avail.	Avail.	Avail.	Avail.
TP349	fr. cm 150,1 to 160	Avail.	Avail.	Avail.	Avail.
TP350	fr. cm 160,1 to 170	Avail.	Avail.	Avail.	Avail.
TP351	fr. cm 170,1 to 180	Avail.	Avail.	Avail.	Avail.
TP352	fr. cm 180,1 to 190	Avail.	Avail.	Avail.	Avail.
TP353	fr. cm 190,1 to 200	Avail.	Avail.	Avail.	Avail.
TP354	fr. cm 200,1 to 210	Avail.	Avail.	Avail.	Avail.
TP355	fr. cm 210,1 to 220	Avail.	Avail.	Avail.	Avail.

2 cm thick marble; 1,6 cm thick crystal glass; 1,2 cm thick Tecnoril

KINDS OF CRYSTAL-MADE INTEGRATED BASIN IN THE TOP

ART. V801 cm 45x29x14h width min. top cm 65 / max 249

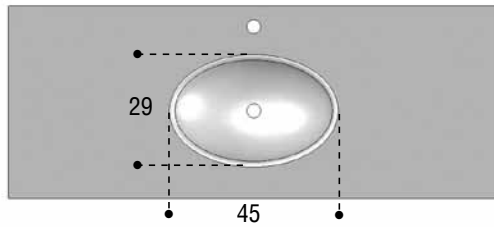

ART. V802 cm 50x34x14h width min. top cm 68 / max 249

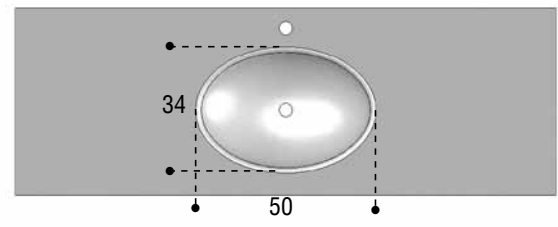

ART. V803 cm 67x31,5x14h width min. top cm 90 / max 249

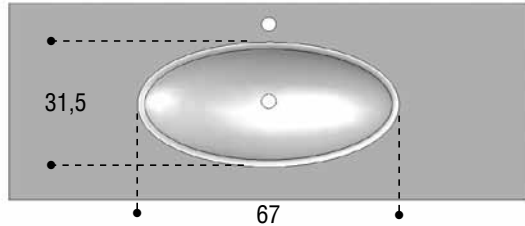

ART. V804 cm 90x34x14h width min. top cm 110 / max 249

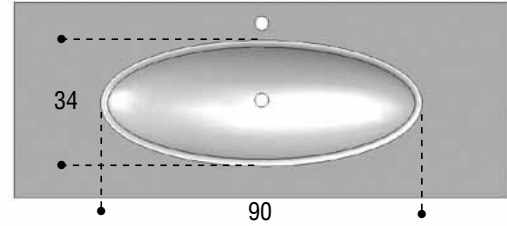

ART. V805 cm 30x30x14h width min. top cm 50 / max 249

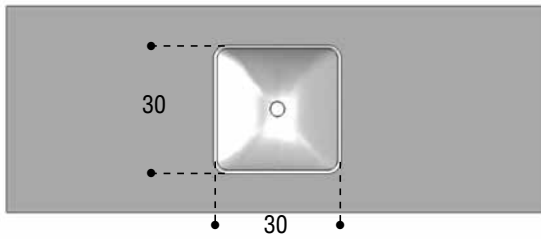

ART. V806 cm 50x31x14h width min. top cm 68 / max 249

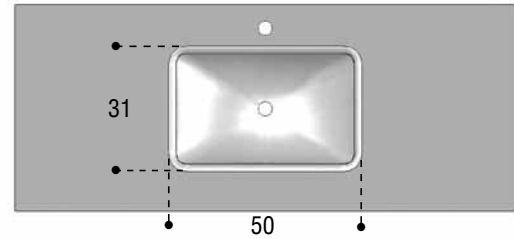

ART. V807 cm 55x31x14h width min. top cm 75 / max 249

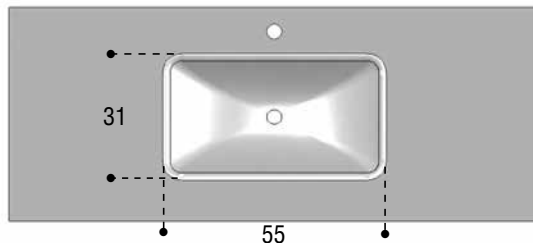

ART. V808 cm 67x31x14h width min. top cm 90 / max 249

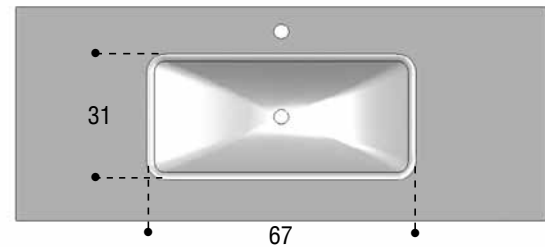

ART. V809 cm 100x36x14h width min. top cm 120 / max 249

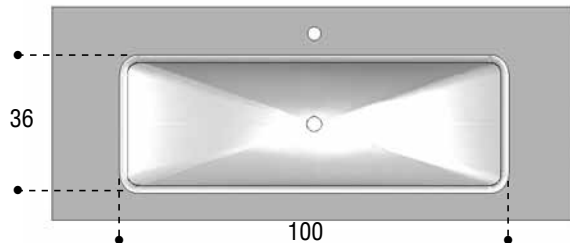

ART. V810 Ø 31 cm width min. top cm 50 / max 249

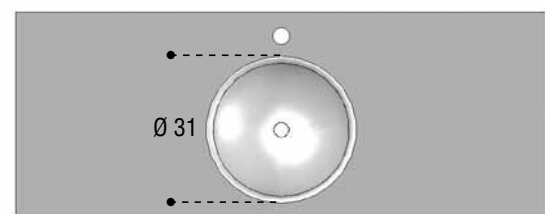

ART. V811 cm 50x30x14h width min. top cm 68 / max 200

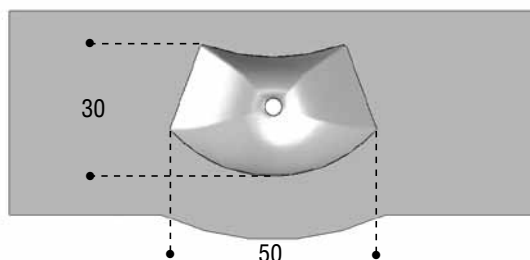

ART. V812 cm 68x31,5x14h width min. top cm 90 / max 200

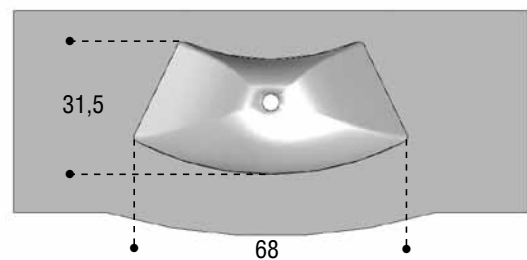

INTEGRATED BASIN-CENTRE, LEFT, RIGHT

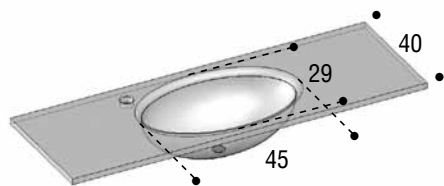

IMPORTANT:

crystal-made tops with basin, 40 d, are available only with integrated basin **Art. V801**,
fr. cm 45L x 29P x 14H

drill for fawcet can be left/right only

surcharge for second drill for basin:

integrated crystal glass **Art. CR133 € XX**

Art.	Width from cm to cm	CATEGORY 5 crystal-made top w/basin			
TP365	up to cm 70	Avail.			
TP366	fr. cm 70,1 to 80	Avail.			
TP367	fr. cm 80,1 to 90	Avail.			
TP368	fr. cm 90,1 to 100	Avail.			
TP369	fr. cm 100,1 to 110	Avail.			
TP370	fr. cm 110,1 to 120	Avail.			
TP371	fr. cm 120,1 to 130	Avail.			
TP372	fr. cm 130,1 to 140	Avail.			
TP373	fr. cm 140,1 to 150	Avail.			
TP374	fr. cm 150,1 to 160	Avail.			
TP375	fr. cm 160,1 to 170	Avail.			
TP376	fr. cm 170,1 to 180	Avail.			
TP377	fr. cm 180,1 to 190	Avail.			
TP378	fr. cm 190,1 to 200	Avail.			
TP379	fr. cm 200,1 to 210	Avail.			
TP380	fr. cm 210,1 to 220	Avail.			

standard / extra clear (optical) crystal glass, 1,6 cm thick

INTEGRATED BASIN-CENTRE, LEFT, RIGHT

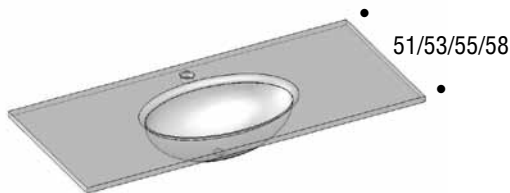

IMPORTANT:

in the order form, always write the kind of integrated basin. pls see p.. 202

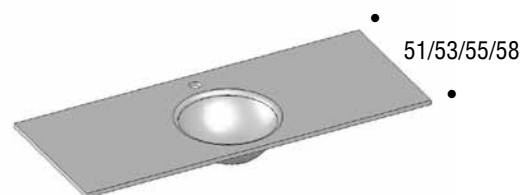
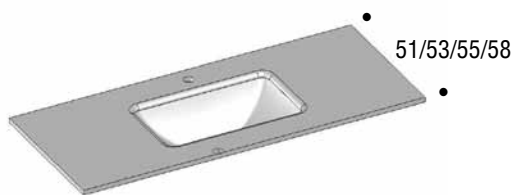

surcharge for second drill for basin:

integrated crystal glass Art. CR133 € XX

Art.	Width from cm to cm	CATEGORY 5 crystal-made top w/basin			
TP400	up to cm 70	Avail.			
TP401	fr. cm 70,1 to 80	Avail.			
TP402	fr. cm 80,1 to 90	Avail.			
TP403	fr. cm 90,1 to 100	Avail.			
TP404	fr. cm 100,1 to 110	Avail.			
TP405	fr. cm 110,1 to 120	Avail.			
TP406	fr. cm 120,1 to 130	Avail.			
TP407	fr. cm 130,1 to 140	Avail.			
TP408	fr. cm 140,1 to 150	Avail.			
TP409	fr. cm 150,1 to 160	Avail.			
TP410	fr. cm 160,1 to 170	Avail.			
TP411	fr. cm 170,1 to 180	Avail.			
TP412	fr. cm 180,1 to 190	Avail.			
TP413	fr. cm 190,1 to 200	Avail.			
TP414	fr. cm 200,1 to 210	Avail.			
TP415	fr. cm 210,1 to 220	Avail.			

standard / extra clear (optical) crystal glass, 1,6 cm thick

INTEGRATED BASIN-CENTRE, LEFT, RIGHT

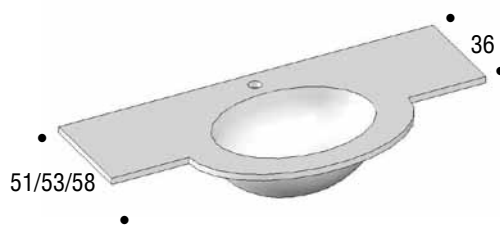
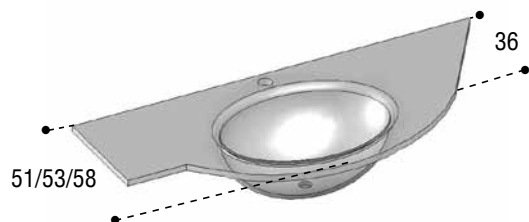

IMPORTANT:

in the order form, always write the kind of integrated basin. pls see p.. 202

surcharge for second drill for basin:

integrated crystal glass Art. CR133 € XX

Art.	Width from cm to cm	CATEGORY 5 crystal-made top w/ basin			
TP500	up to cm 70	Avail.			
TP501	fr. cm 70,1 to 80	Avail.			
TP502	fr. cm 80,1 to 90	Avail.			
TP503	fr. cm 90,1 to 100	Avail.			
TP504	fr. cm 100,1 to 110	Avail.			
TP505	fr. cm 110,1 to 120	Avail.			
TP506	fr. cm 120,1 to 130	Avail.			
TP507	fr. cm 130,1 to 140	Avail.			
TP508	fr. cm 140,1 to 150	Avail.			
TP509	fr. cm 150,1 to 160	Avail.			
TP510	fr. cm 160,1 to 170	Avail.			
TP511	fr. cm 170,1 to 180	Avail.			
TP512	fr. cm 180,1 to 190	Avail.			
TP513	fr. cm 190,1 to 200	Avail.			
TP514	fr. cm 200,1 to 210	Avail.			
TP515	fr. cm 210,1 to 220	Avail.			

standard / extra clear (optical) crystal glass, 1,6 cm thick

KINDS OF INTEGRATED TECNORIL BASIN

ART. B079 cm 50x31x11h width min. top cm 60 / max 250

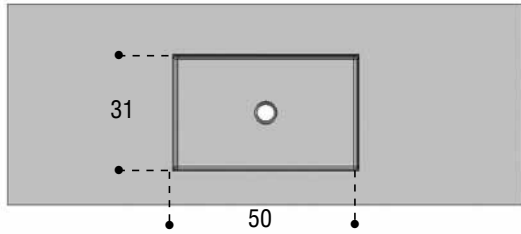

ART. B105 cm 60x31,5x11h width min. top cm 68 / max 251

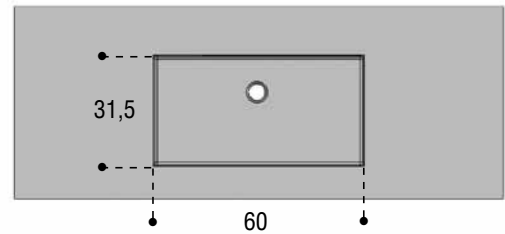

ART. B032 cm 70x31x11h width min. top cm 80 / max 272

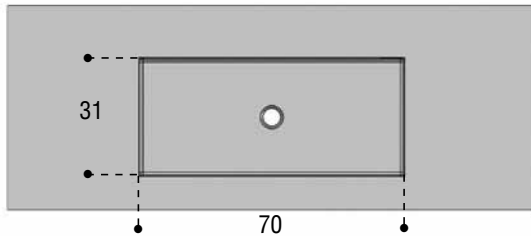

ART. B132 cm 80x31x11h width min. top cm 90 / max 271

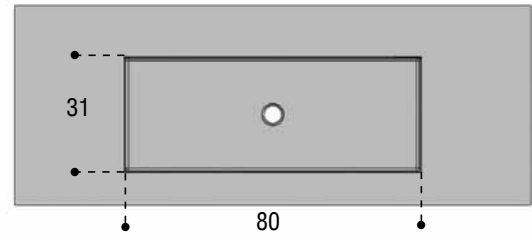

ART. B197 cm 50x25x10h width min. top cm 60 / max 270

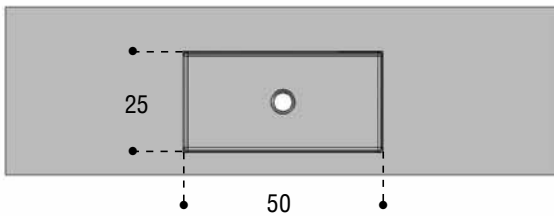

ART. B198 cm 70x25x10h width min. top cm 80 / max 270

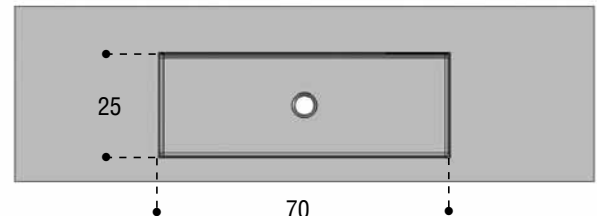

ART. B122 cm 50x34x13h width min. top cm 60 / max 250

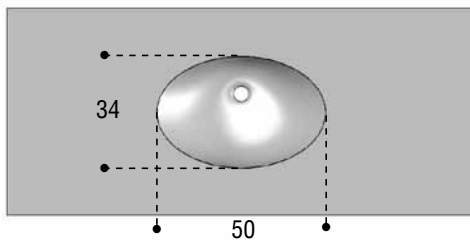

ART. B181 cm 63x34x13h width min. top cm 80 / max 250

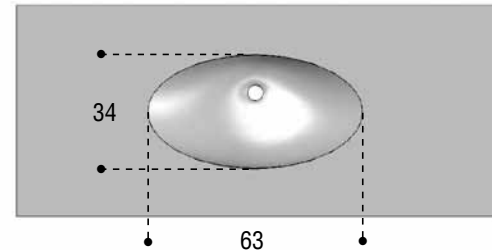

ART. B124 cm 79x35x13h width min. top cm 90 / max 250

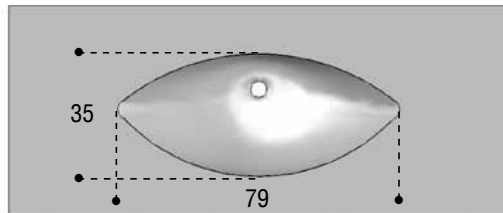

ART. B133 cm 64x33,5x12h width min. top cm 68 / max 250

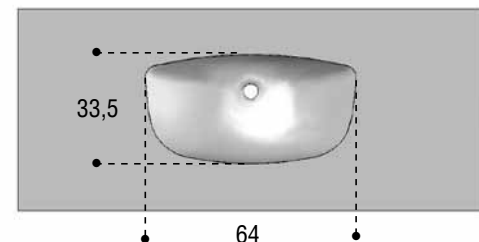

ART. B203 cm 55x36,5x14h width min. top cm 60 / max 270

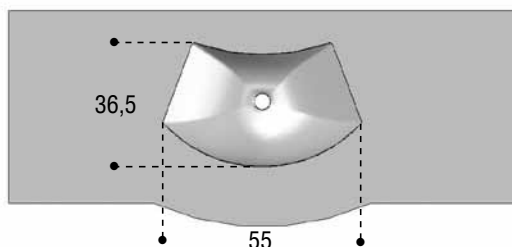

ART. B164 cm 76x34x14h width min. top cm 90 / max 270

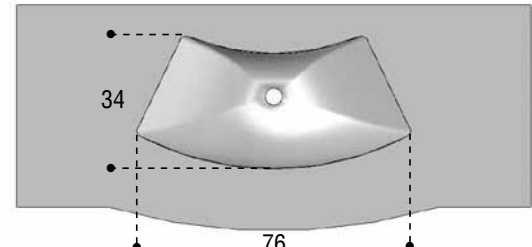

INTEGRATED BASIN-CENTRE, LEFT, RIGHT

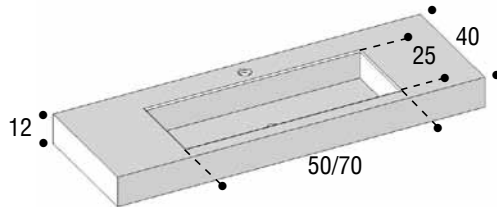
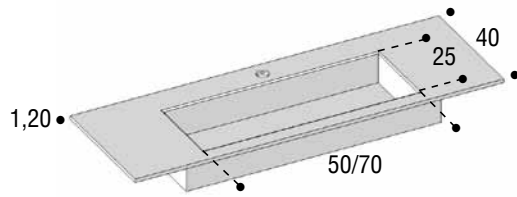

IMPORTANT:

Tecnoril-made tops w/basin are available only with:

- **rectangular integrated basin Art. B197, from cm 50L x 25P x 10H**
- **rectangular integrated basin Art. B198, from cm 70L x 25P x 10H**

surcharge for second drill for basin:

Tecnoril integrated Art. TE134 € XX

Art.	Width from cm to cm	CAT. 6 Tecnoril integrated, 1,2 cm thick		CAT. 6 Tecnoril integr. boxed, 1,2 cm thick	
		mat	polished	mat	polished
TP313	up to cm 70	Avail.	Avail.	Avail.	Avail.
TP314	fr. cm 70,1 to 80	Avail.	Avail.	Avail.	Avail.
TP315	fr. cm 80,1 to 90	Avail.	Avail.	Avail.	Avail.
TP316	fr. cm 90,1 to 100	Avail.	Avail.	Avail.	Avail.
TP317	fr. cm 100,1 to 110	Avail.	Avail.	Avail.	Avail.
TP318	fr. cm 110,1 to 120	Avail.	Avail.	Avail.	Avail.
TP319	fr. cm 120,1 to 130	Avail.	Avail.	Avail.	Avail.
TP320T	fr. cm 130,1 to 140	Avail.	Avail.	Avail.	Avail.
TP321T	fr. cm 140,1 to 150	Avail.	Avail.	Avail.	Avail.
TP322T	fr. cm 150,1 to 160	Avail.	Avail.	Avail.	Avail.
TP323T	fr. cm 160,1 to 170	Avail.	Avail.	Avail.	Avail.
TP324T	fr. cm 170,1 to 180	Avail.	Avail.	Avail.	Avail.
TP325T	fr. cm 180,1 to 190	Avail.	Avail.	Avail.	Avail.
TP326T	fr. cm 190,1 to 200	Avail.	Avail.	Avail.	Avail.
TP327T	fr. cm 200,1 to 210	Avail.	Avail.	Avail.	Avail.

Mat/polished Tecnoril thick 1,2 cm

INTEGRATED BASIN-CENTRE, LEFT, RIGHT

IMPORTANT:

in the order form, always write the kind of Tecnoril-made basin. pls see p. 206

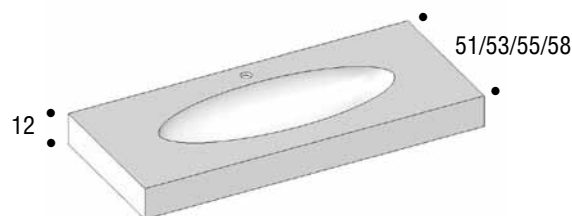
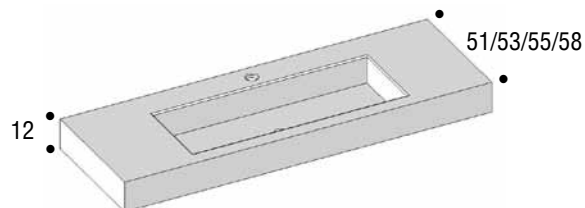
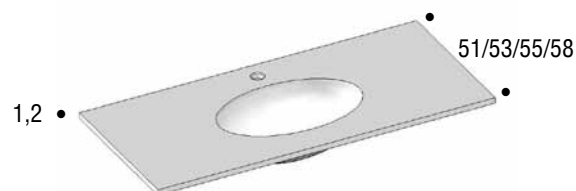
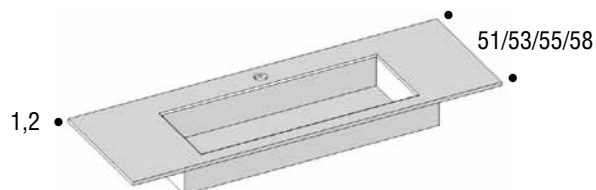

surcharge for second drill for basin:

Tecnoril integrated Art. TE134 € XX

Art.	Width from cm to cm	CAT. 6 Tecnoril integrated, 1,2 cm thick		CAT. 6 Tecnoril integr. boxed, 1,2 cm thick	
		mat	polished	mat	polished
TP560	up to cm 70	Avail.	Avail.	Avail.	Avail.
TP561	fr. cm 70,1 to 80	Avail.	Avail.	Avail.	Avail.
TP562	fr. cm 80,1 to 90	Avail.	Avail.	Avail.	Avail.
TP563	fr. cm 90,1 to 100	Avail.	Avail.	Avail.	Avail.
TP564	fr. cm 100,1 to 110	Avail.	Avail.	Avail.	Avail.
TP565	fr. cm 110,1 to 120	Avail.	Avail.	Avail.	Avail.
TP566	fr. cm 120,1 to 130	Avail.	Avail.	Avail.	Avail.
TP567	fr. cm 130,1 to 140	Avail.	Avail.	Avail.	Avail.
TP568	fr. cm 140,1 to 150	Avail.	Avail.	Avail.	Avail.
TP569	fr. cm 150,1 to 160	Avail.	Avail.	Avail.	Avail.
TP570	fr. cm 160,1 to 170	Avail.	Avail.	Avail.	Avail.
TP571	fr. cm 170,1 to 180	Avail.	Avail.	Avail.	Avail.
TP572	fr. cm 180,1 to 190	Avail.	Avail.	Avail.	Avail.
TP573	fr. cm 190,1 to 200	Avail.	Avail.	Avail.	Avail.
TP574	fr. cm 200,1 to 210	Avail.	Avail.	Avail.	Avail.
TP575	fr. cm 210,1 to 220	Avail.	Avail.	Avail.	Avail.

Mat/polished Tecnoril, 1,2 cm thick

INTEGRATED BASIN-CENTRE, LEFT, RIGHT

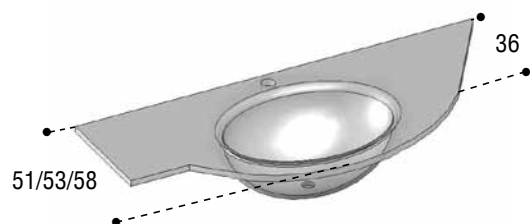
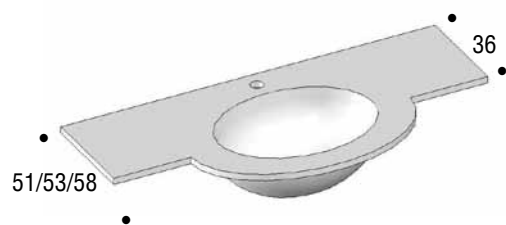

IMPORTANT:

in the order form, always write the kind of Tecnoril-made basin. pls see p. 206

surcharge for second drill for basin:

Tecnoril integrated Art. TE134 € XX

Art.	Width from cm to cm	CAT. 6 Tecnoril integrated, 1,2 cm thick			
		mat	polished		
TP449	up to cm 70	Avail.	Avail.		
TP450	fr. cm 70,1 to 80	Avail.	Avail.		
TP451	fr. cm 80,1 to 90	Avail.	Avail.		
TP452	fr. cm 90,1 to 100	Avail.	Avail.		
TP453	fr. cm 100,1 to 110	Avail.	Avail.		
TP454	fr. cm 110,1 to 120	Avail.	Avail.		
TP455	fr. cm 120,1 to 130	Avail.	Avail.		
TP456	fr. cm 130,1 to 140	Avail.	Avail.		
TP457	fr. cm 140,1 to 150	Avail.	Avail.		
TP458	fr. cm 150,1 to 160	Avail.	Avail.		
TP459	fr. cm 160,1 to 170	Avail.	Avail.		
TP460	fr. cm 170,1 to 180	Avail.	Avail.		
TP461	fr. cm 180,1 to 190	Avail.	Avail.		
TP462	fr. cm 190,1 to 200	Avail.	Avail.		
TP463	fr. cm 200,1 to 210	Avail.	Avail.		
TP464	fr. cm 210,1 to 220	Avail.	Avail.		

Mat/polished Tecnoril, 1,2 cm thick

TOP W/ HALF BUILT-IN: BASIN-CENTRE, LEFT, RIGHT

IMPORTANT:

On order always specify the location of the sink.
It is not available with double sink.

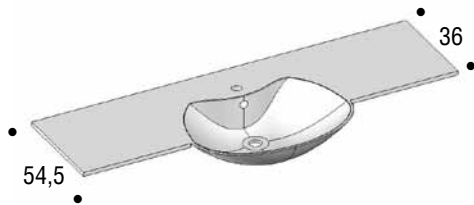

Art.	Width	Top w/half built-in basin, 1,2 cm thick	
SCP-68	cm 68	Avail.	
SCP-72	cm 72	Avail.	
SCP-85	cm 85	Avail.	
SCP-92	cm 92	Avail.	
SCP-102	cm 102	Avail.	
SCP-109	cm 109	Avail.	
SCP-116	cm 116	Avail.	
SCP-119	cm 119	Avail.	
SCP-126	cm 126	Avail.	
SCP-133	cm 133	Avail.	
SCP-136	cm 136	Avail.	
SCP-140	cm 140	Avail.	
SCP-143	cm 143	Avail.	
SCP-150	cm 150	Avail.	
SCP-153	cm 153	Avail.	
SCP-160	cm 160	Avail.	
SCP-164	cm 164	Avail.	
SCP-170	cm 170	Avail.	
SCP-177	cm 177	Avail.	
SCP-184	cm 184	Avail.	
SCP-187	cm 187	Avail.	
SCP-194	cm 194	Avail.	
SCP-201	cm 201	Avail.	
SCP-204	cm 204	Avail.	

Mat/polished Tecnoril, 1,2 cm thick



SPLASHBOARD TOP, price per meter

Element	Art.	Width	Height	Depth	Category	Euro
 <p>SPLASHBOARD price per meter</p>	AL71	per meter	6	2	category 1	Avail.
	AL75	per meter	6	2	category 2	Avail.
	AL80	per meter	6	2	category 3	Avail.
	AL85	per meter	6	2	category 4	Avail.

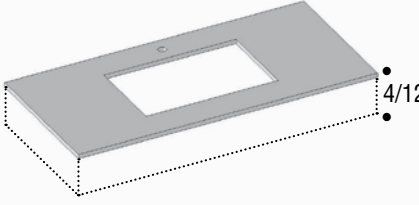
Undertop structure, 45° junction, glued to the top (boxed)

Element	Art.	Width	Height	Category	Euro
 <p>undertop structure, 45° junction, glued to the 2 side panels + front panel, 45° cut and glued to the top price per meter Height min. cm 4 max. cm 12</p>	AL90	per meter	4/12	category 1	Avail.
	AL91	per meter	4/12	category 2	Avail.
	AL92	per meter	4/12	category 3	Avail.
	AL93	per meter	4/12	category 4	Avail.

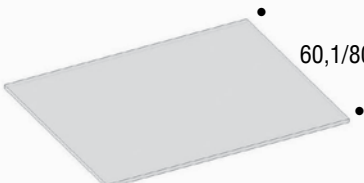
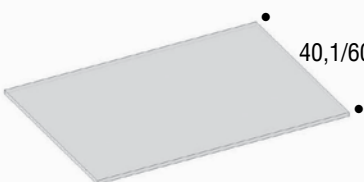
CRISTAL-MADE TOP MADE TO MEASURE-PRICE PER METER

Element	Art.	Width	Height	Rectangular	Shaped		
 <p>60,1/80</p> <p>from cm 60,1 to 80 D</p>	BCM-17	per meter	1,6	Avail.	Avail.		
 <p>40,1/60</p> <p>from cm 40,1 to 60 D</p>	BCM-18	per meter	1,6	Avail.	Avail.		
 <p>20/40</p> <p>from cm 20 to 40 D</p>	BCM-19	per meter	1,6	Avail.	Avail.		
 <p>6</p> <p>crystal glass rectangular splashboard</p>	BCM-22	0 - 99,9 100-159,9 160 - 210	6 6 6	Avail. Avail. Avail.			

Crystal-made top w/total transparent basin (tt110) +12%

Crystal-made top w/basin max. Width 249 cm – crystal-made top 280 cm wide

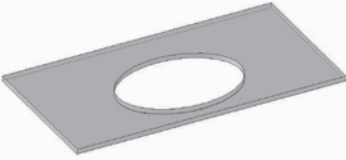
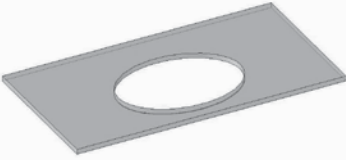
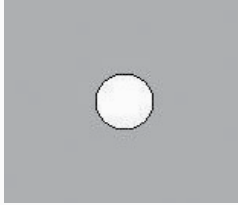
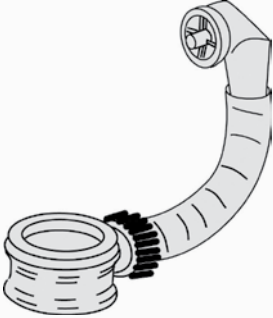

The edge is squared. On request and with no surcharge, it can be bull-headed or howl-beaked

MACHINING ON TOPS IN CRYSTAL GLASS TOPS CUSTOMIZED



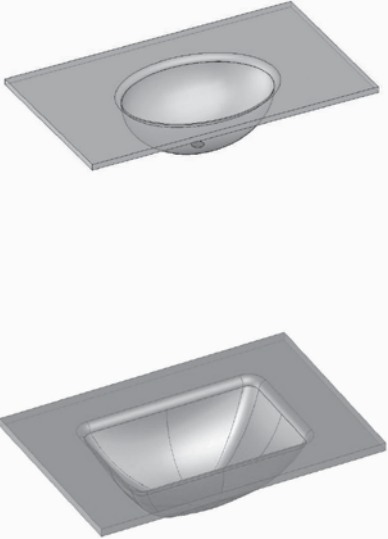
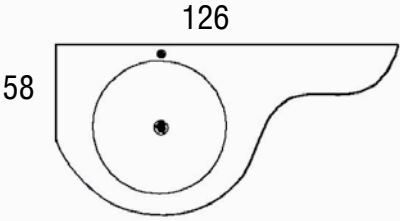

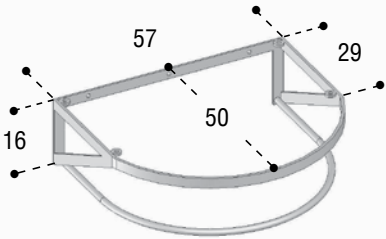
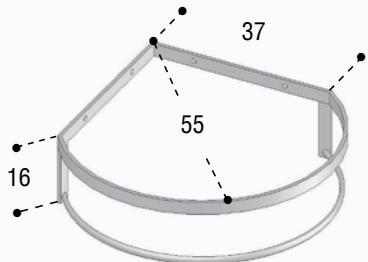
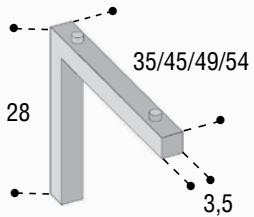
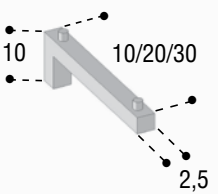
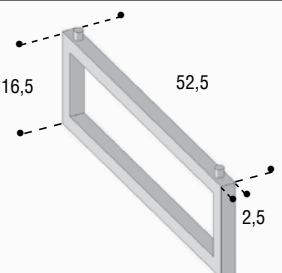
Element	Art.	Width	Height	€			
 cut for half built-in basin	LAV 1C			Avail.			
 polished drill for undertop basin	LAV 2C			Avail.			
 polished drill for undertop basin	LAV 3C			Avail.			
 drill for overtop basin or basin to lean	LAV 4C			Avail.			
 overflow kit	LAV 5C			Avail.			

INTEGRATED BASINS FOR CRYSTAL-MADE TOPS MADE TO MEASURE

Element	
	<p style="text-align: center;">Surcharge for integrated basin on top made to measure:</p> <p style="text-align: center;">(For size and shape of integrated basins, pls see p. 202)</p> <p> integrated basins art. V801 € Avail. integrated basins art. V802 € Avail. integrated basins art. V803 € Avail. integrated basins art. V804 € Avail. integrated basins art. V805 € Avail. integrated basins art. V806 € Avail. integrated basins art. V807 € Avail. integrated basins art. V808 € Avail. integrated basins art. V809 € Avail. integrated basins art. V810 € Avail. integrated basins art. V811 € Avail. integrated basins art. V812 € Avail. </p>
	<p style="text-align: center;">Example for calculating the price of a crystal-made top made to measure</p> <p>- Shaped crystal-made top like in the drawing aside Crystal-made top w/basin art v810 + drill for tap Price per meter of shaped top 58 cm deep= XX €</p> <p> $XX \text{ €} \times YY \text{ (width)} - ZZ \text{ €}$ $XX \text{ €} + YY \text{ € (integrated basin art v810)} = ZZ \text{ €}$ $XX \text{ €} + YY \text{ € (drill for tap)} = XX \text{ total price}$ *the edge cut is included </p>



Element	Art.	Width	Depth	Brass chrome Pol.	brass chrome satin.	Steel Satined	Steel Polished
 <p>brass support for crystal-made top</p>	BCS-1	57	16	Avail.	Avail.		
	BCS-2 (no towel rack)	57	16	Avail.	Avail.		
 <p>brass support for top art. BCT-7</p>	BCS-3	55	16	Avail.	Avail.		
 <p>satined/polished steel bracket</p>	BCS-5/35	3,5	35			Avail.	Avail.
	BCS-5/45	3,5	45			Avail.	Avail.
	BCS-5/49	3,5	49			Avail.	Avail.
	BCS-5/54	3,5	54			Avail.	Avail.
 <p>satined/polished steel bracket</p>	BCS-5/10	2,5	10			Avail.	Avail.
	BCS-5/20	2,5	20			Avail.	Avail.
	BCS-5/30	2,5	30			Avail.	Avail.
 <p>steel bracket for towels</p>	BCS-7	52,5	16,5			Avail.	Avail.
 <p>steel round bar for towels, for bracket art. BCS-5 and art. BCS-7. Price per meter</p>	BCP-30	m	Ø20			Avail.	Avail.

WOODEN TOP MADE TO MEASURE - Price per meter

Element	Art.	Shape	Height	Width	Lacquered Mat	Lacquered Glossy	Veneered
 <p>2 cm thick top to lean</p>	from 30 to 54,9 MCM2 MCM2	Rectangular Shaped	2 2	price per meter, brackets not incl., max 300 cm	Avail. Avail.	Avail. Avail.	Avail. Avail.
	from 55 to 70 MCM3 MCM3	Rectangular Shaped	2 2		Avail. Avail.	Avail. Avail.	Avail. Avail.
2 cm thick tops are available only to lean							
 <p>4 cm thick hanging</p>	from 30 to 54,9 MCM5 MCM5	Rectangular Shaped	4 4	price per meter, brackets not incl., max 300 cm	Avail. Avail.	Avail. Avail.	Avail. Avail.
	from 55 to 70 MCM6 MCM6	Rectangular Shaped	4 4		Avail. Avail.	Avail. Avail.	Avail. Avail.
For hanging tops, pls add the cost of 2 brackets art 151 up to 150 cm wide, over 150 cm wide, add 3 brackets.							
 <p>6 cm thick hanging</p>	from 30 to 54,9 MCM8 MCM8	Rectangular Shaped	6 6	price per meter, brackets not incl., max 300 cm	Avail. Avail.	Avail. Avail.	Avail. Avail.
	from 55 to 70 MCM9 MCM9	Rectangular Shaped	6 6		Avail. Avail.	Avail. Avail.	Avail. Avail.
For hanging tops, pls add the cost of 2 brackets art 151 up to 150 cm wide, over 150 cm wide, add 3 brackets.							
 <p>8 cm thick hanging</p>	from 30 to 54,9 MCM11 MCM11	Rectangular Shaped	8 8	price per meter, brackets not incl., max 300 cm	Avail. Avail.	Avail. Avail.	Avail. Avail.
	from 55 to 70 MCM12 MCM12	Rectangular Shaped	8 8		Avail. Avail.	Avail. Avail.	Avail. Avail.
For hanging tops, pls add the cost of 2 brackets art 151 up to 150 cm wide, over 150 cm wide, add 3 brackets.							
 <p>hanging boxed top or to lean</p>	from 30 to 54,9 MCM14	Rectangular	10	price per meter, brackets not incl., max 300 cm	Avail.	Avail.	Avail.
	from 55 to 70 MCM15	Rectangular	10		Avail.	Avail.	Avail.
For hanging tops, pls add the cost of 2 brackets art 151 up to 150 cm wide, over 150 cm wide, add 3 brackets.							

WOODEN TOP MAX. WIDTH 300 CM . 2 CM THICK TOPS ARE AVAILABLE ONLY TO LEAN.
For hanging top, add 2 brackets for width up to 150 cm. Over 150 cm, add 3 brackets.

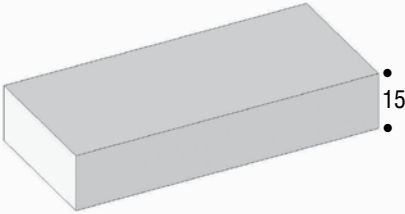
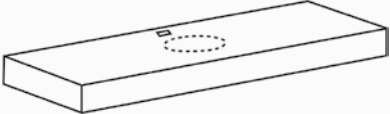
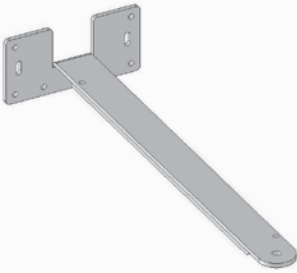
WOODEN TOP MADE TO MEASURE - Price per meter

Element	Art.	Shape	Height	Width	Lacquered Mat	Lacquered Glossy	Veneered
 <p>hanging / to lean boxed top, 15 cm</p>	from 30 to 54,9 MCM17	Rectangular	15	price per meter, brackets not incl., max 300 cm	Avail.	Avail.	Avail.
	from 55 to 70 MCM18	Rectangular	15		Avail.	Avail.	Avail.
<p>For hanging tops, pls add the cost of 2 brackets art 151 up to 150 cm wide, over 150 cm wide, add 3 brackets.</p>							
 <p>surcharge for drill for basin</p>	T50				Avail.		
 <p>price of bracket for top</p>	T51 (for wooden top thick 4-6-8-10-15 cm)				Avail.		
 <p>shaped leg w/adjustable foot</p>	GA0010		70,5	6	Avail.	Avail.	Avail.

WOODEN TOP MAX. WIDTH 300 CM . 2 CM THICK TOP ARE AVAILABLE ONLY TO LEAN.
For hanging top, add 2 brackets for width up to 150 cm. Over 150 cm, add 3 brackets.

EXAMPLES OF WOODEN TOP MADE TO MEASURE

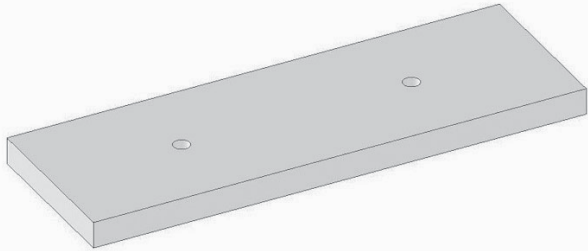
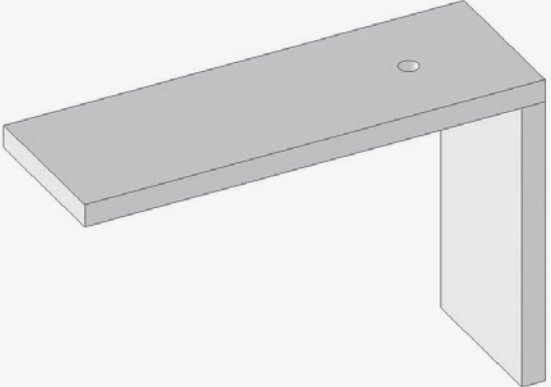
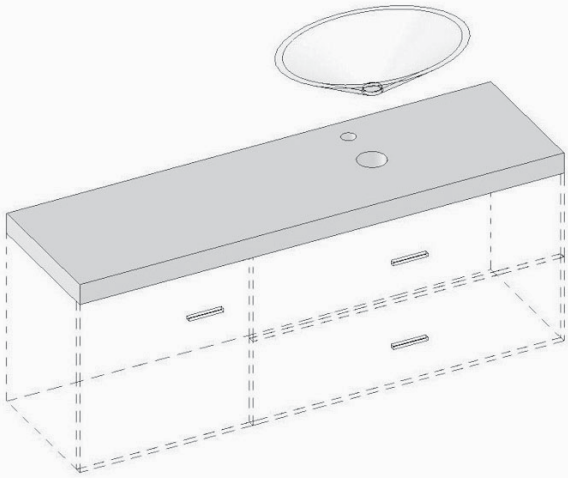
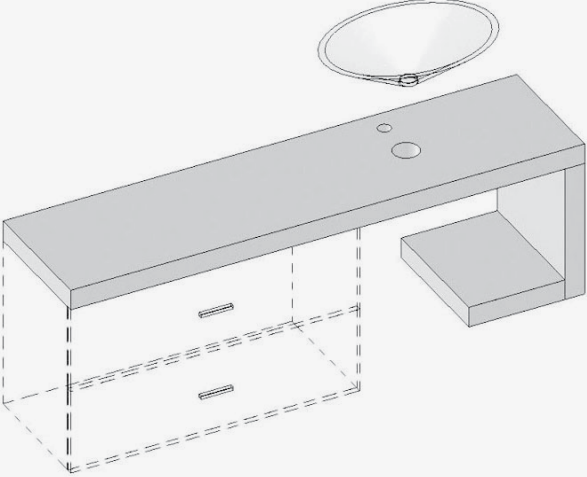
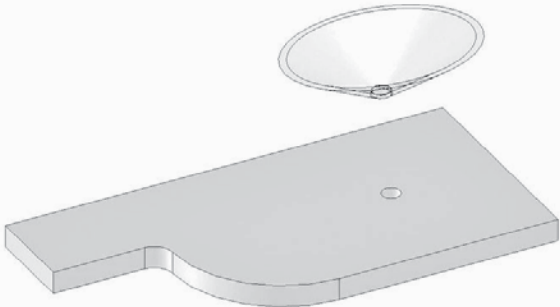
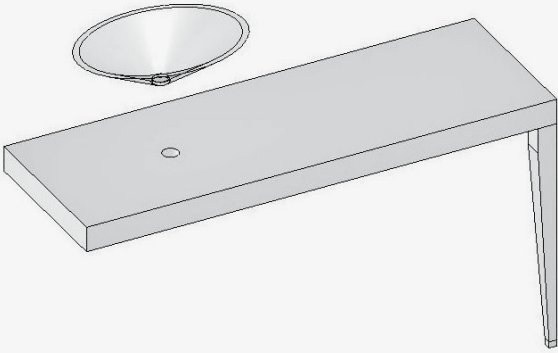
Element		Element
 <p data-bbox="369 811 651 848">Hanging top w/brackets</p>		 <p data-bbox="1097 800 1667 864">Hanging top w/brackets and side panel to floor (in this case one side panel replaces one bracket)</p>
 <p data-bbox="360 1456 660 1492">Leaned top on base units</p>		 <p data-bbox="1166 1442 1594 1505">Leaned top on base units (the side panel replaces one bracket)</p>
 <p data-bbox="311 2095 711 2131">Hanging shaped top with brackets</p>		 <p data-bbox="1179 2095 1576 2131">Hanging top with leg Art. GA0010</p>